



ALMOST HEAVEN
SAUNAS®

Newport Hybrid Sauna Installation & Owner's Manual



HYBRID





Newport Hybrid Sauna Installation & Owner's Manual

Read this entire manual through to the end before proceeding with the assembly.

Thank you for your purchase of your Hampton indoor sauna!
Should you have any questions during assembly,
please feel free to call us at **888.355.3050**,
or email **sales@almostheaven.com**.
Regular business hours are 9-5 EST, M-F.

Your Hampton Indoor Sauna is specifically designed to utilize your existing floor. As such, assembly is made very simple since the entire sauna sits on pre-fabricated rails and risers. Your sauna can be assembled on any surface that is firm and flat, including concrete, ceramic, vinyl, laminate or tile. Installation on a carpeted surface is not recommended.

NOTE: Your Newport hybrid sauna requires two dedicated 20 amp outlets for proper operation. A separate hard-wired 220V, 30 amp circuit is required for the traditional sauna heater.



Pre-Assembly Suggestions

While you can move the completed Newport very gently by sliding it across the floor, we suggest that you assemble the sauna in the location where you plan to use it.

Terms such as “left” and “right” refer to the location when facing the completed sauna from the front, or glass side.

Place the floor section in the location where you will want the sauna and position the rear wall so that it is on the outside of the floor section as shown (1). Find the rear wall sections, left and right, and position so that they are outside the floor section. You can distinguish left and right by the upright boards beneath the heater panels as shown in image (2). Clip the buckles on the back side of the rear wall sections to draw them together (3). Find the right wall section (with single heater panel) and position so that it is outside the floor section and aligns with the rear wall section (4).



Image 1



Image 2

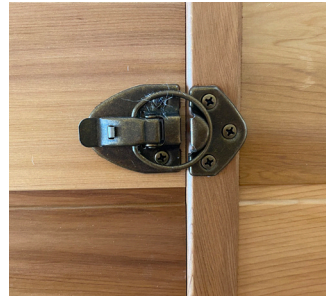

Image 3



Image 4

Screw the right wall section to the rear wall using the 3” screws as shown (5). Find the left wall section (with three heater panels) and position so that it is outside the floor section and aligns with the rear wall section. Screw to the rear wall using 3” screws. Figure (6) shows the inside of the sauna after side and rear walls are in place. Note: The floor section is not attached to any of the walls (6). Position the right bench support to the outside of the long vertical board on the rear wall (7). Screw the right bench support in place as shown (8).



Image 5

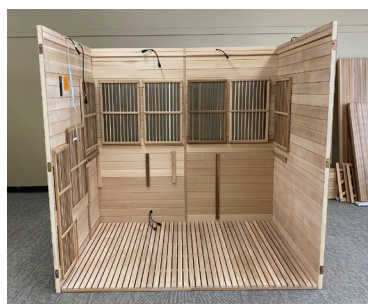

Image 6



Image 7



Image 8

Find the front lower bench support with single heater. Place the left side between the vertical boards on the left wall and position against the vertical board on the right bench support as shown. Screw in place (9). Plug one of the wires from the rear wall section into the wire from the bench support. This connection will power the floor heating panel located on the front bench support (10). Place the lower bench over the front and right bench supports. It will be supported by the bench supports as well as vertical support boards located on the side wall and right-side bench support (11). Find the front upper bench support. Position and screw in place as shown. Plug into second wire coming from rear panel (12).



Image 9



Image 10



Image 11



Image 12

Place the upper bench in place which will be supported by side and rear wall horizontal supports and right-side bench support (13). View of interior of sauna after benches are in place(14). Secure the back rest to the rear wall using 2" screws. Note: Be sure the back rest is level and positioned approximately 2" above the bench (15). Find the 2 vertical front wall frame pieces which have slotted brackets as well as 2 horizontal frame pieces with notched tongues protruding from the ends (16).



Image 13



Image 14

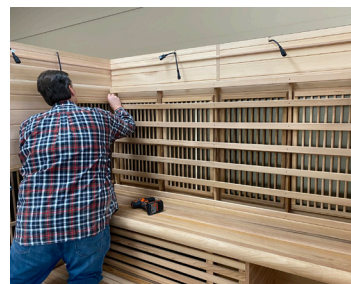

Image 15



Image 16

Using a rubber mallet, gently tap the side frame pieces into the lower horizontal frame piece (17). Screw the horizontal frame piece to the vertical frame piece as shown (18). Lean the partially completed front wall frame against a wall with the horizontal support at the floor. Note: the vertical frame pieces should have the wide part of the slotted bracket down and the narrow slot up (19). Find the two front glass panels and place them in the grooves on the lower horizontal support and the end supports as shown. Note the window with the hinge holes in the side. Be sure the holes are to the center of the front wall of the sauna, on the left or right side depending on which way you want the door to swing (20).



Image 17

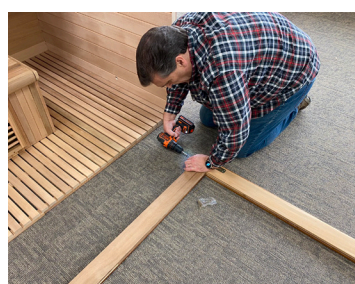

Image 18



Image 19



Image 20



Position the top horizontal frame piece, ensuring that the glass is in the grooves and the tongue fits into the groove on the vertical frame pieces. Screw into place as shown (21). With two people, position the assembled front wall section so that the pins align with the slots (22). Gently lift the front wall section so that the pin will insert into the large portion of the slot at the top, middle and bottom of each side (23). Then lower the wall section so that the pin slides into the narrow part of the slots. This will secure the front wall section to the left and right wall sections. Use a rubber mallet if necessary, to assist in lowering the front wall section to the height of the left and right wall sections (24).



Image 21



Image 22



Image 23



Image 24

Find the heater wire connections at the top of the panels and move them so they lay to the outside of the sauna for now. This is so that they do not interfere with positioning the roof section (25). Find the roof section and remove the thin protective dust cover that is secured with small screws. Place the roof section over the top of the sauna and lower between the walls so that it rests on the supports at the top of the wall sections. Note: The power boxes on the top side of the roof should be to the rear of the sauna (26). Connect the heater wires, laying the wire into the groove that is cut into the roof section. This will ensure that the dust cover can be reinstalled without interfering with the wires. Be sure that the wires plugs are fully connected and seated securely into the receptacles (27). Screw the roof section into the rear and side wall sections as shown. Use 4 screws on the rear and two on each of the side walls (28).



Image 25



Image 26



Image 27



Image 28

Feed the power connectors through the holes in the dust cover and reposition the dust cover over the roof section. Re-attach the dust cover to the roof section (29). Find the door handle and disassemble (30). Reattach the door handle to the holes located in the glass door. Note: Tighten screws until they are snug, but not overly tight (31). Find the two door hinges and hex wrench and disassemble the hinges (32).



Image 29

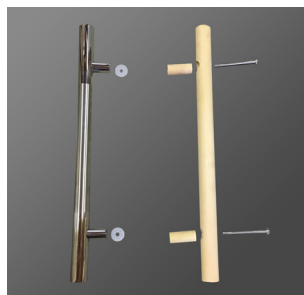

Image 30

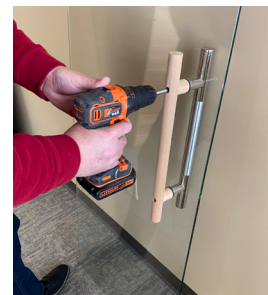

Image 31



Image 32



Reattach the hinges to the door, tightening with the hex wrench so they are snug. Note: You may have to loosen the screws again when the door is attached to adjust the fit of the door. Once the fit is completed you may tighten the screws in the hinges (33). Place the door into the opening and attached the hinges to the door the same way you did to the window. You will likely need to loosen some hinge screws on the door and/or window to align and get the correct fit (34). Attach the magnetic door latch to the top of the door frame. Note: Do not fully tighten the door latch until you are sure that the door will properly secure to the latch (35). Slide the metal catch over the door to align with the magnetic door latch as shown (36).

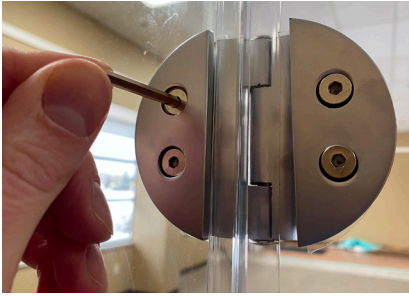

Image 33



Image 34



Image 35



Image 36

Install the traditional heater according to the instructions in the heater manual. This will include mounting the heater to the wall of the sauna with mounting screws, with the bottom of the heater being approximately 7" from the floor of the sauna. Be sure that the screws are at the same height (37). Lower the heater onto the mounting screws (38). Assemble the heater fence (39). Place the heater fence in front of the traditional heater (40).



Image 37



Image 38



Image 39

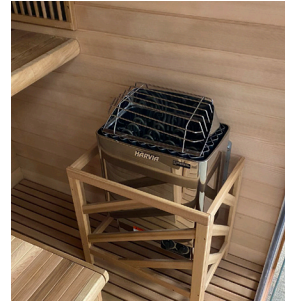
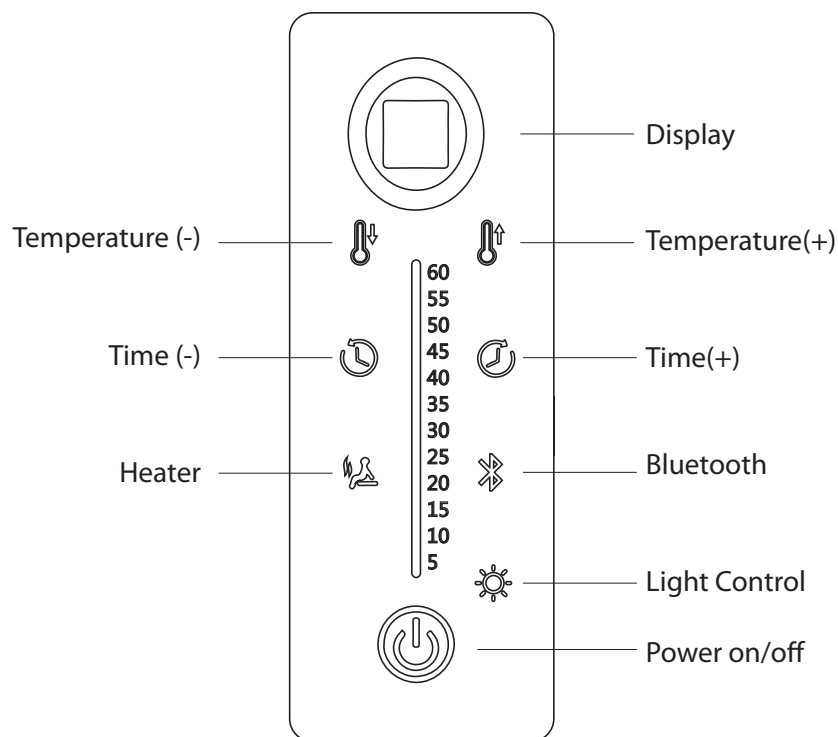

Image 40

WARNING: Never operate the infrared heaters and the traditional heaters at the same time. Operate one or the other, depending on the type of sauna you would like to enjoy.





CONTROL OPERATION

Power On/Off

Turn on the system by pushing and holding the Power button for 4 seconds until the green lights on the display are lit. Turn the system off by pushing the Power button a second time for 1 second. The red light on the Power button indicate the system is turned off. All of the sauna functions will only operate when the system is on and the panel is green.

Infrared Heater Operation

With the display on, press the Heater button, which will immediately turn green. This indicates that the infrared heater panels are heating.

To adjust the temperature, press the Temperature (-) or Temperature (+) to raise or lower the set temperature. The temperature is displayed in Celsius, with the lowest temperature setting being 30°C (86°F) and the maximum temperature setting being 70°C (158°F). Pressing the temperature buttons will raise or lower the temperature by 1° each time the button is pressed. After 8 seconds the display will indicate the actual temperature in the sauna.

The heaters can operate to a maximum of 60 minutes, and you can adjust the heating time with the Time (-) or Time (+) buttons. You will add 1 minute to the time each time you press the Time button. After 8 seconds the display will show the time remaining. When there are 5 minutes left in the cycle the timer will sound 3 times to remind you that your session is ending. When the heaters turn off after 60 minutes you can reset the timer if you wish to keep the heaters on for another cycle.

Bluetooth Function

To activate Bluetooth, press the Bluetooth button which will immediately turn green. Turn on the Bluetooth function on our Bluetooth device and pair to BT Audio. You can now listen to music from your device and control the volume



from your device. The speakers are located above the ceiling and are not visible from inside the sauna.

Lighting

To turn on the overhead light, press the Light button, which will immediately turn green on the display. The color of the overhead light will be the same as when the unit was last turned off. The light has 9 settings which display as L1-L9. The settings are as follows: L1=white, L2=red+blue, L3=blue, L4=blue+green, L5=green, L6=green+red, L7=red, L8=all colors, L9=fade from color to color. To change the light setting press the Light button and hold for 5 seconds. Then press the button and let go to get to the setting you'd like. The system will exit the Light function after 8 seconds.

High Temp Limit

You should never operate the infrared and traditional heaters at the same time. The infrared system will not operate if the temperature in the room is 80°C, so be sure the room cools off after using the traditional heater before operating the infrared heaters.

Sensor Fault Detection

An EO indicator on the display panel means there is an open circuit and you should check your circuit breaker to be sure it is not tripped. The plug on your infrared sauna requires a 20amp dedicated circuit.

An E1 indicator on the display panel means that there is some sort of short in the circuit, and you should contact your electrician.

